



# ASSEMBLY INSTRUCTIONS

Applicable to the following models:  
55011, 55022, 55044, 55077, 55088, 55099, 56011, 56022, 56044



Remove the contents from the tent storage bag. Unroll the tent and ensure that all components are present. In this bag you will find the following items:

<u>Item</u>	<u>Quantity</u>
Tent	1
Rain Fly	1
Pole Bag	1
Stake Bag	1

<u>Included in Pole Bag</u>		<u>Diameter(mm)</u>	
Side-to-Side Pole - Grey Pole	POLE "A"	8.5	1
Corner-to-Corner Pole -Blue Pole	POLE "B"	9.5	2
Tailgate Pole - Olive Pole	POLE "C"	8.5	1
Inside Pole - Black Pole	POLE "D"	7.9	1
Telescoping Awning Pole-Green Pole			2

<u>Included in Stake Bag</u>	
Steel Stake	4
Awning Cord	4
Rubber Cap	4

**NOTE: Pole "B" and "C" are similar in length but different in diameter.**

### Warnings

Failure to observe the following warnings may result in damage to your vehicle.

Once the tent has been installed, do not use these products while the vehicle's engine is in operation. Do not attempt to drive the vehicle or attempt to move the vehicle.

If your vehicle has recently been painted, you must wait a minimum of three months prior to installing your sportz tent. The paint must be allowed to cure completely during this time so as to not damage the paint.

Do not install the tent when your vehicle is wet and the temperature is below freezing as the tent may freeze onto the vehicle.

### Before You Start

Before installing this product onto your vehicle you must perform the following:

Park the vehicle on a level section of ground. Do not attempt to install this product when your vehicle is parked on an incline.

Place the vehicle's transmission into park and engage the parking brake.

Turn off the vehicle's ignition and allow the exhaust pipe to cool for a minimum of 20 minutes. By doing so, this will prevent personal injury from the exhaust heat and will prevent exhaust heat damage to the tent. Do not attempt to install this product onto the vehicle when the engine is in operation.

### Caring For Your Tent

Please refer to the label sewn into your tent for care information.



# 1-800-567-2434

*Designed For The Great Outdoors*

All Napier tent products are patented under US and International laws © 2006

SHEET **1** OF **8**

## Installation Instructions

1. Drop the tailgate of the truck to the down position.
2. Unfold the tent in the bed of your truck. Make sure the tent door is facing the back (or tailgate) of your truck.
3. Loosely attach the three straps on each side of the truck by hooking the middle straps under the wheel well and the outside straps under the truck body. The sides of the tent should slightly overlap the top of the truck bed.

Note: Do not cinch the straps at this point.

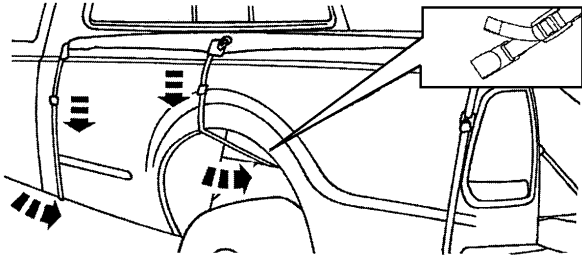

4. Loosely attach the three straps at the back of the truck around the tailgate. The male clip slips between the truck box and the tailgate and wraps around the tailgate to then clip to the female clip under the tailgate.

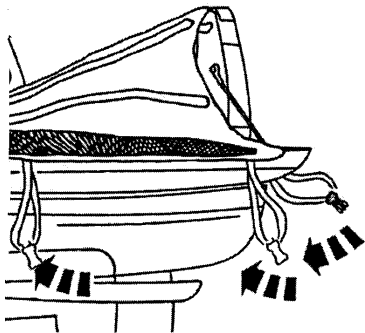

Pole A-Grey  
Pole B-Blue  
Pole C-Olive  
Pole D-Black

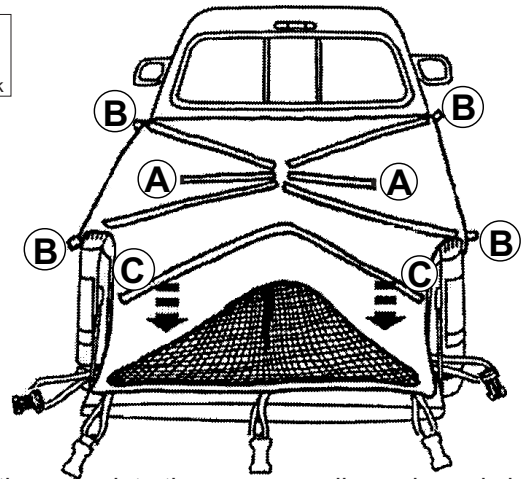

5. Insert the poles into the corresponding coloured sleeves.
6. Insert the ends of each pole into their corresponding pocket on the tent, first with the corner to corner (Blue) pole (B) and then the side to side (grey) pole (A). When you do this, the poles will arch the tent. Attach the clips from the tent on each pole to support the tent.

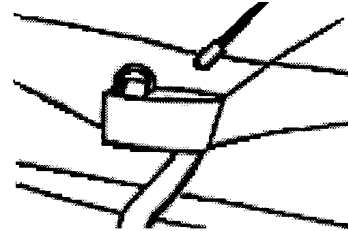

POLE IN POCKET

7. Insert the tailgate pole (olive) (C) into the corresponding green strip sleeve and fasten the tent clips to the pole.
8. Open the door and insert the black inside pole (D) by placing each end into the pockets located at the front and back of the tent's inside ceiling. Position the pole in the center of the roof and secure it using the velcro straps (E) sewn into the centerline hem of the tent. Once the tent is standing, cinch the straps tightly around the truck bed to ensure a snug fit.

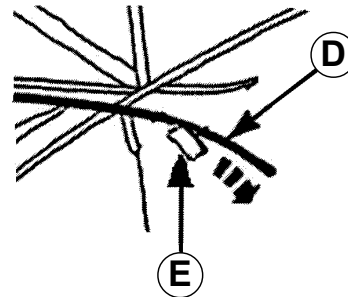

All Napier tent products are patented under US and International laws © 2006

### Awning Assembly

1. Assemble both telescoping awning poles (making sure the piece with the locking mechanism is closest to the ground). (A) Adjust height accordingly.
2. Make sure you have all four ground pegs and guide wires, there are two wires and two ground pegs to ensure sturdiness.
3. Insert the poles into the grommets of the canopy.
4. Drive two stakes into the ground approximately four feet away from the base of each pole and away from the vehicle. (B)

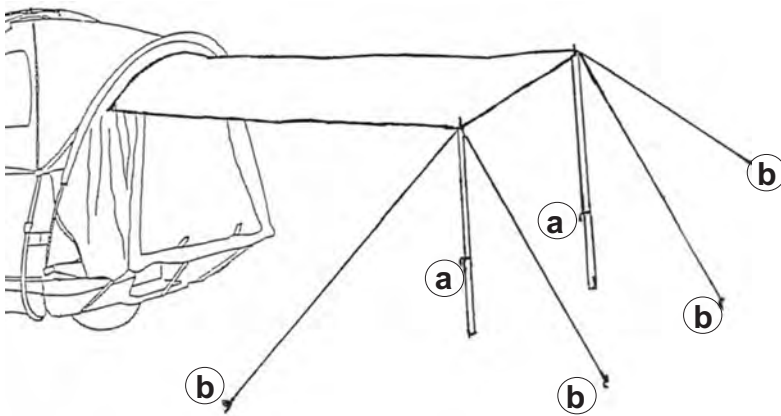

**Optional** -If you wish to omit setting up the canopy, roll up the canopy and secure it with the loops located on either side above the door.

5. Using two cords per pole, place the metal ring of each cord over the top of the pole. Place the loop of each cord over the hooked end of each stake as shown below.

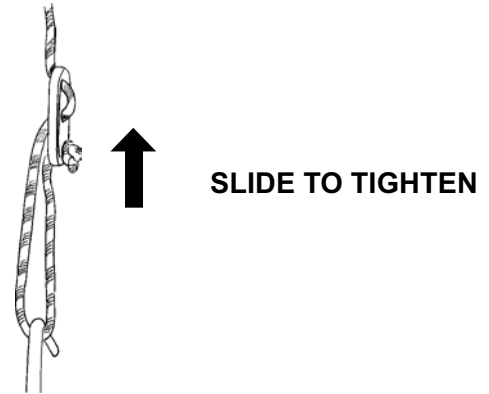

6. Place rubber caps onto both top ends of each telescoping pole as shown to hold the poles in position. (C)

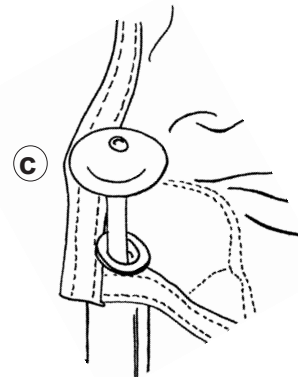

TELESCOPING AWNING POLE WITH RUBBER CAP

### Rain Fly Assembly

1. Clip the rain fly into place by securing the male clips (1) to the female clips (2) around the tent located at each corner and under each window. Cinch the straps tightly.
2. Attach the two velcro strips on the front of the rain fly.

Note: The rain fly must be used when the tent is subjected to inclement weather as this will ensure that the interior of the tent remains dry.

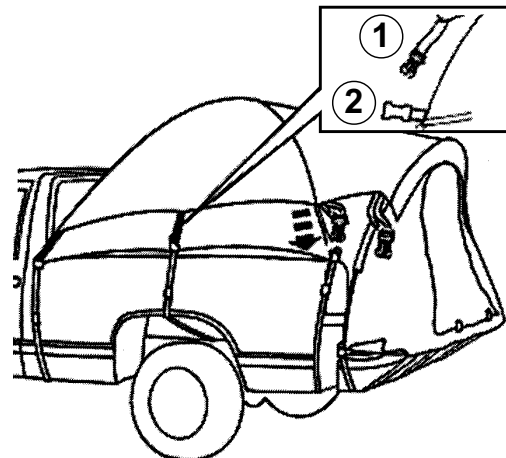



## TENT CARE TIPS



To further the life of your tent the following care suggestions are recommended:

1. **NEVER ROLL UP OR PACK AWAY A WET TENT. THIS WILL CAUSE MILDEW. MILDEW WILL DESTROY THE COTTON THREAD USED IN YOUR TENT SEAMS.**
2. Store your tent in a dry place.
3. Avoid spraying insect repellent, hair spray, etc., inside or near your tent, as they may be harmful to the tent fabric and cause leakage. Acids and caustic solutions can damage nylon. This includes leaking flashlight batteries, ascorbic acid in fruit juices, etc.
4. Cleaning tent. Hand wash with a sponge, using soap such as Ivory flakes. Never use washing machine or detergent as they may damage the seams or the coating.
5. Condensation. The human body gives off a considerable amount of moisture during the night. If this moisture cannot escape from the tent, it will condense on the inner surface and make it wet. Condensation droplets may drop off, which may appear like leakage or misting. *THIS DOES NOT MEAN THAT THE TENT LEAKS.* If your door flap and windows are left open or partially open, this condition will reduce itself.
6. This material has been scientifically treated with the finest water resistant chemicals. However, under severe weather conditions, some water may penetrate. We suggest using a fly to keep you cool and dry.
7. Warranty. All tents are guaranteed against defects in material and workmanship only. No tents are to be returned for repairs or credit without prior authorization from the manufacturer. Your tent warranty is valid for 1 year.
8. The nylon material in your tent has been treated with ultra violet inhibitor. However, prolonged exposure in the sun will affect the strength of the material.
9. If zippers stick, lubricate with silicon. Never force a zipper that has material caught in it, as this will bend the slider and prevent the zipper from closing. Continual use in a sandy environment can cause a slider to erode and fail to close the zipper.

**WARNING:** \_\_\_\_\_  
VEHICLE MUST REMAIN STATIONARY WHILE THE TENT IS ERECTED IN THE BED OF THE TRUCK

**WARNING:** \_\_\_\_\_  
KEEP ALL FLAME AND HEAT SOURCES AWAY FROM THIS TENT FABRIC

**NOTE:** \_\_\_\_\_  
THIS TENT IS MADE WITH FLAME RESISTANT FABRIC. IT IS NOT FIREPROOF. THE FABRIC WILL BURN IF LEFT IN CONTINUOUS CONTACT WITH ANY FLAME SOURCE.

### **A TENT IS NOT WATERPROOF, IT IS WATER REPELLANT**

#### Warranty Procedures:

Should this product require service within the first 30 days after purchase, Napier strongly recommends that you return the product to the place of purchase for replacement. Please note this 30-day replacement period may be subject to the limitations of the return policy that has been established by your retailer, may not be available at your retailer, or may be for a different period of time as established by your retailer. Your retailer may allow exchanges past this 30-day period. Should this be the case, Napier strongly recommends that you return the product to the place of purchase for replacement.

#### To Obtain Service Under the Terms of this Warranty:

In the event you are unable to obtain a replacement product from your retailer, please do the following:

1. Send a copy of your original sales receipt showing original purchase date, along with your mailing address and a note describing the nature of the problem to:

Napier Enterprises  
Warranty Processing  
2315 Whirlpool St. Suite 161  
Niagara Falls, NY 14305

#### **DO NOT RETURN PRODUCT TO THIS ADDRESS!**

2. You will receive a return authorization number within 7-12 business days from the date your return request is received if it is determined that there is a basis for a replacement product. The return authorization form you receive will list the return procedures, applicable charges, if any, and the correct shipping address for the returned product.

#### **Product Support Hotline:**

For questions on the use of this product call 800-567-2434, Monday through Friday between the hours of 9:00am and 5:00pm EST. You can also e-mail Napier at customerservice@napierenterprises.com. Allow one to two weeks for e-mail response.

**⚠ WARNING****BEFORE YOU START**

Before installing this product onto your vehicle you must perform the following:

Park the vehicle on a level section of ground. Do not attempt to install this product when your vehicle is parked on an incline.

Turn off the vehicle's ignition and allow the exhaust pipe to cool for a minimum of 20 minutes. By doing so, this will prevent personal injury from the exhaust heat and will prevent damaging the tent on the muffler.

Place the vehicle's transmission into park (automatic transmission) or gear (manual transmission) and engage the parking brake.

Do not attempt to install this product onto the vehicle when the engine is in operation.

Do not start the vehicle while the tent is assembled.

To prevent carbon monoxide from entering the vehicle and tent area, do not run the engine, cook inside the tent, use a gas heater in the tent, etc. Carbon monoxide is dangerous and it can cause unconsciousness or death.

To prevent personal injury and damage to the tent, engine must be off and exhaust must be fully cooled before tent installation and use.

Please exercise caution when entering and exiting the tent.

DO NOT use candles, matches or open flames of any kind in or near the tent.

DO NOT cook inside the tent.

DO NOT smoke inside the tent.

DO NOT store flammable liquids inside the tent.

No open flames should be in or near the tent.

Build campfires several yards from the tent.

At all times, you must unzip the windows for proper ventilation.

Failure to observe the following cautions may result in damage to your vehicle.

Once the tent has been installed, do not use this product while the vehicle's engine is running. Do not attempt to drive or move the vehicle after the tent is installed.

If your vehicle has been painted, you must wait a minimum of three months to allow the paint to cure completely before installing your tent, otherwise, the paint may be damaged.

Do not install the tent when your vehicle is wet and the temperature is below freezing as the tent may freeze onto the vehicle.